

Edge E system

600x600, 1200x600,
625x625, 1250x625
(Not valid for Combison)

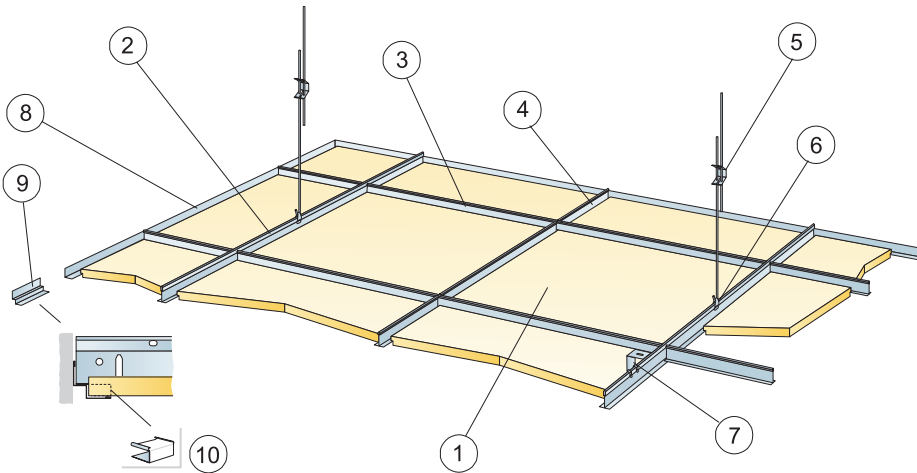
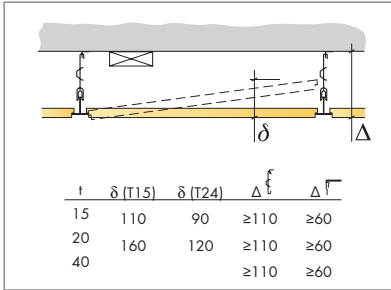

1. Ecophon edge E panel 600x600/1200x600
625x625/1250x625

2. Connect T24 or T15 Main runner

3. Connect T24 or T15 Cross tee,
L=1200/1250

4. Connect T24 or T15 Cross tee,
L=600/625

5. Connect Adjustable hanger

6. Connect Hanger clip

7. Connect Direct fixing bracket

8. Connect Angle trim

9. Connect Shadow-line
trim

10. Connect E-plugg (T24)

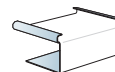
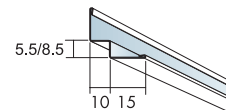
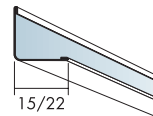

t=20

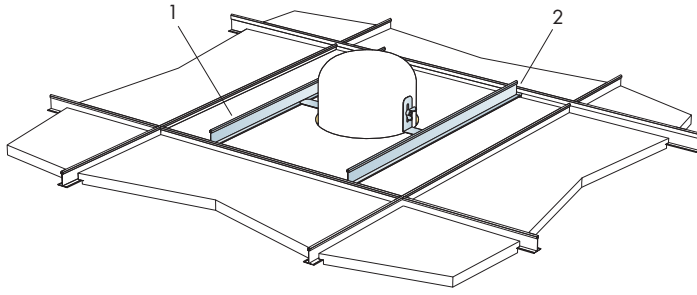

→ 18

1. Connect Bridging profile

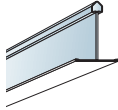

2. Connect Bridging clip 7/10



t=15

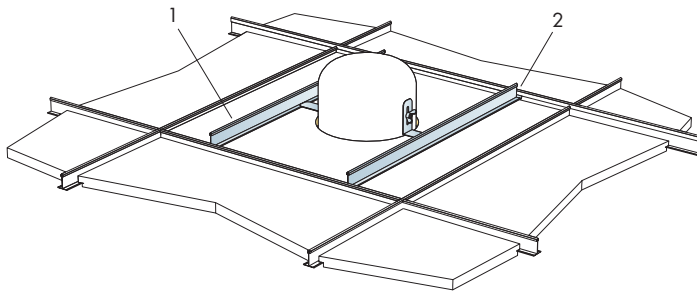

→ 19

1. Connect Bridging profile

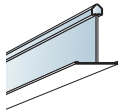

2. Connect Bridging clip 7/10



Ecophon[®]
SAINT-GOBAIN

A SOUND EFFECT ON PEOPLE

www.ecophon.com

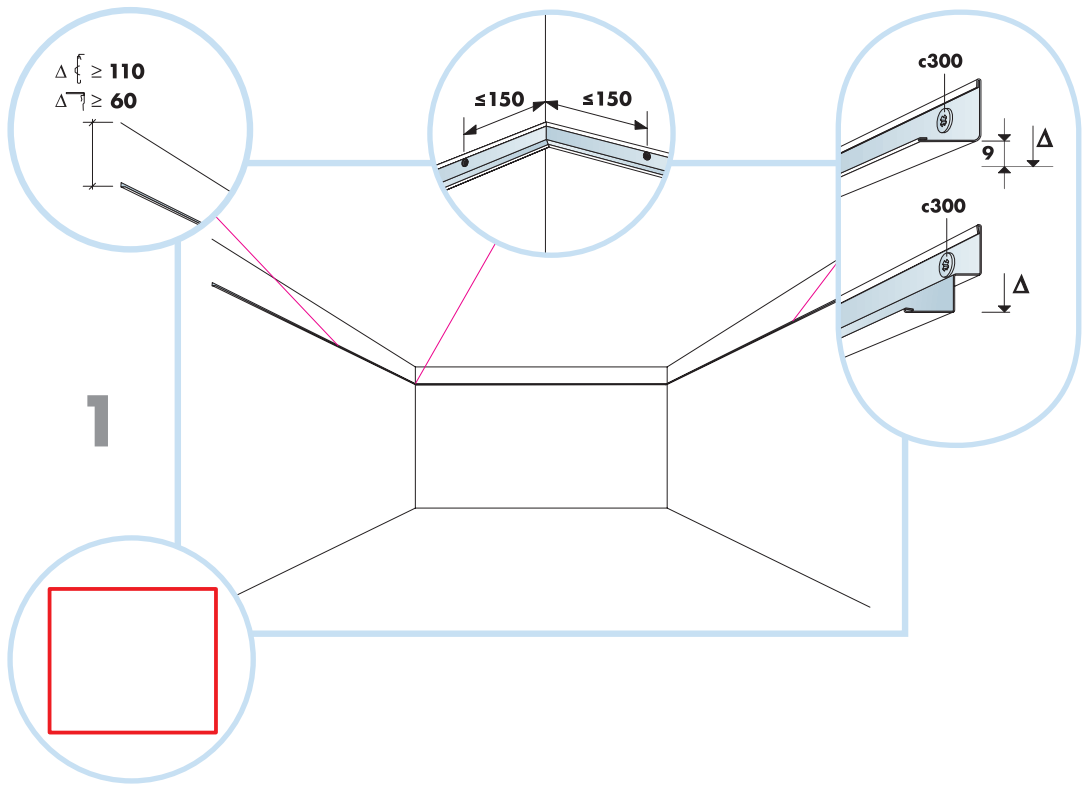

1

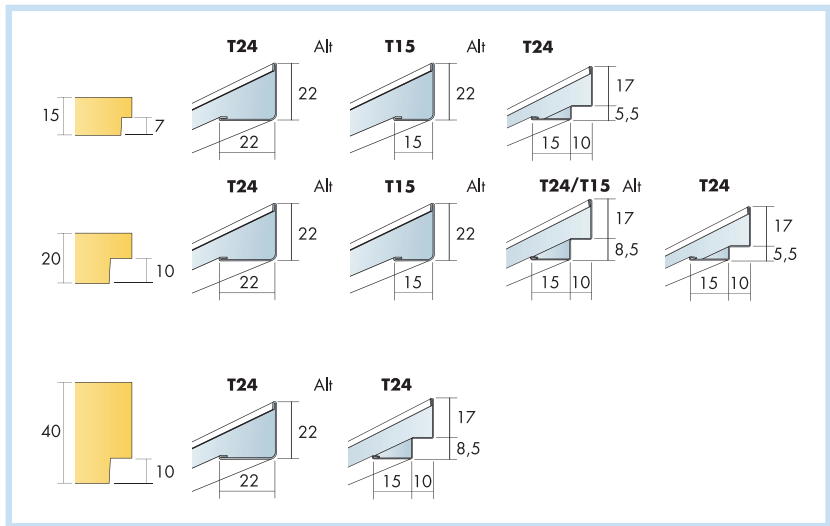

2

3

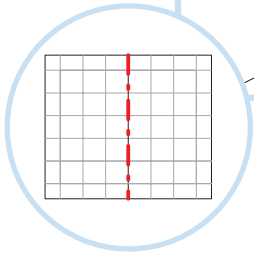
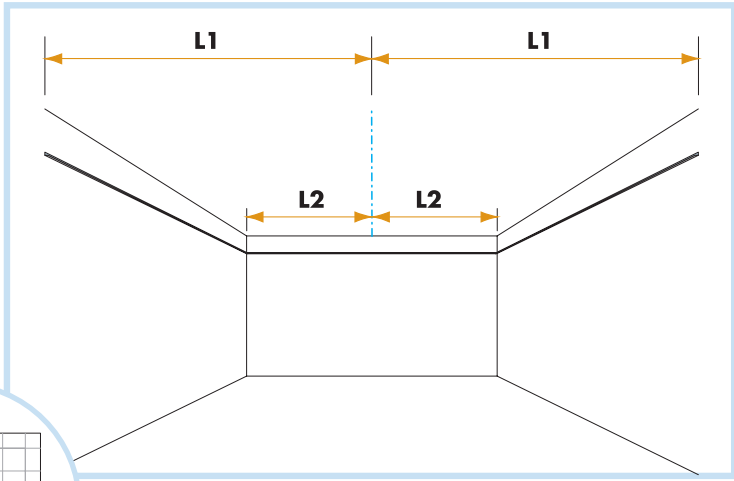

$A < 300$

4

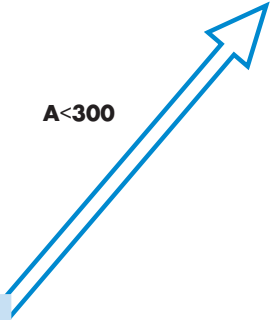
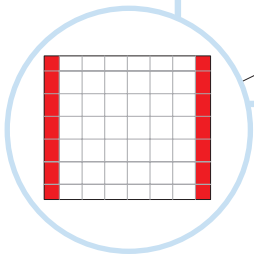
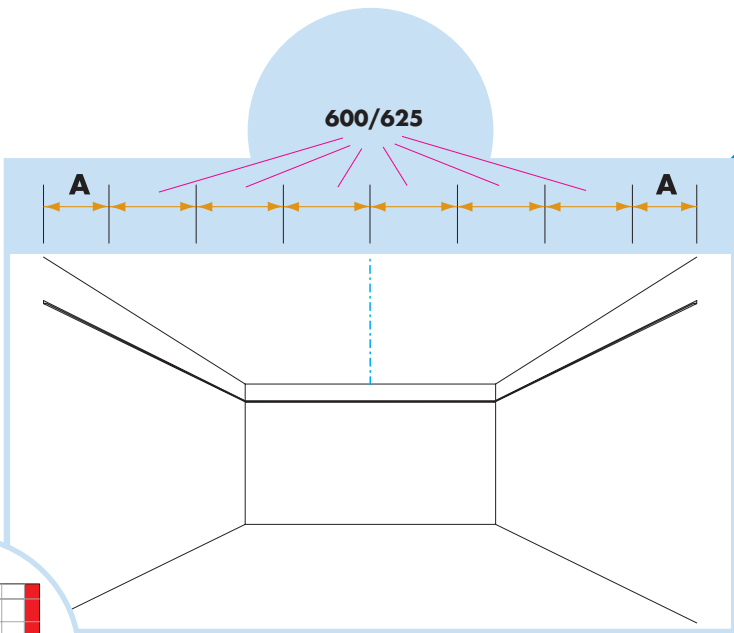

$A \geq 300$

5

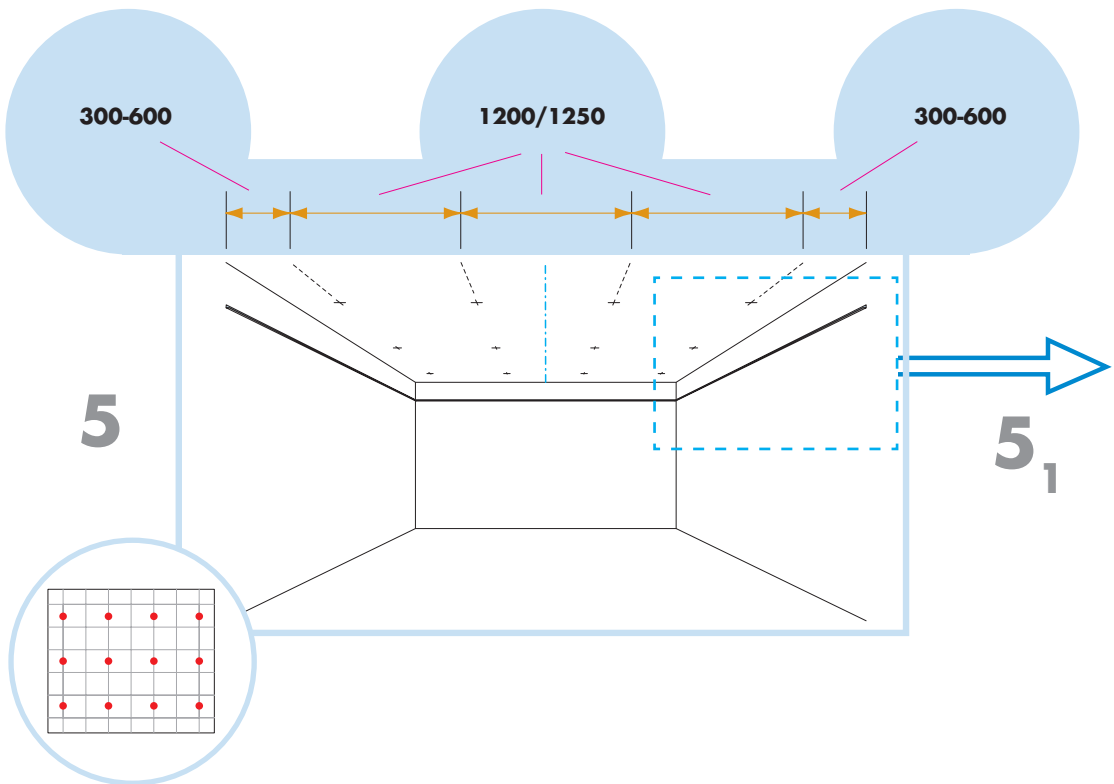
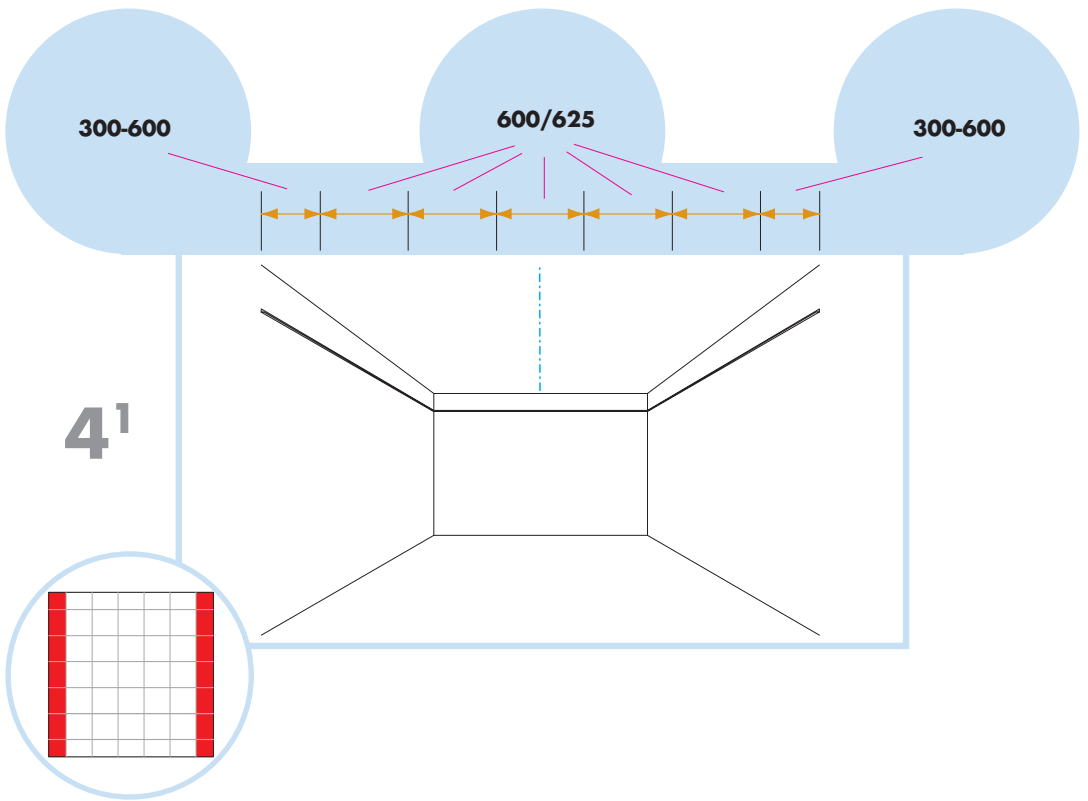

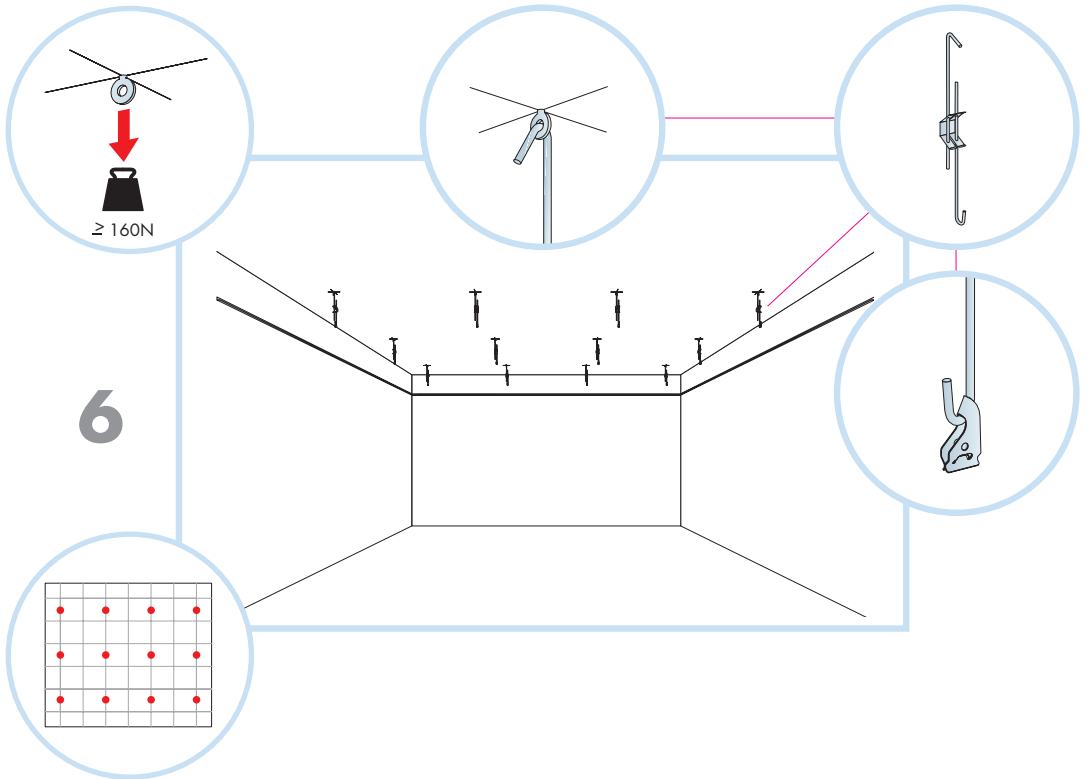
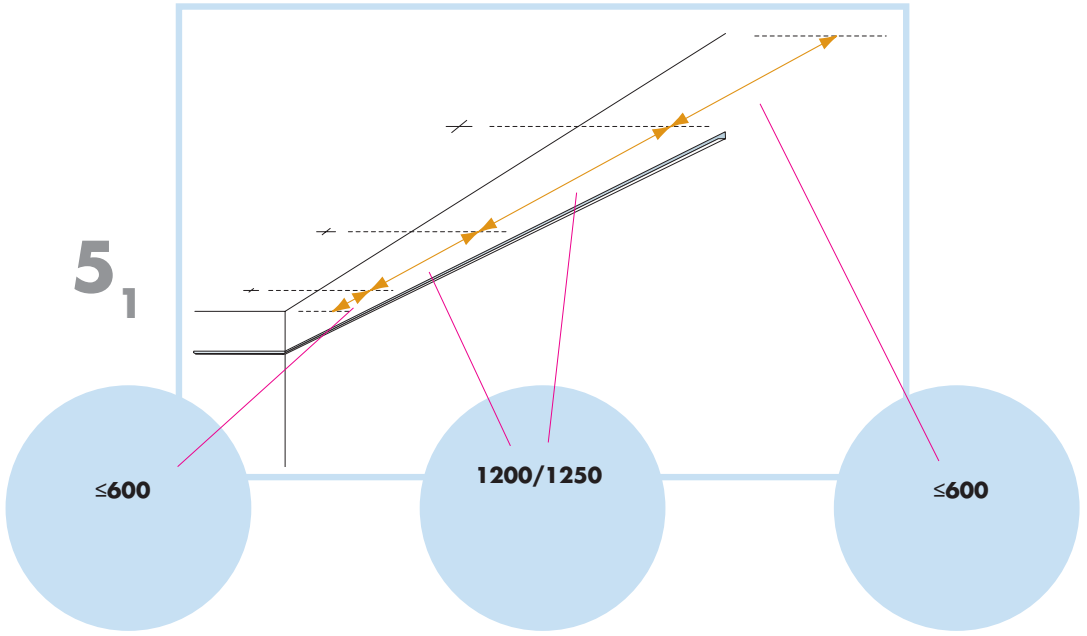

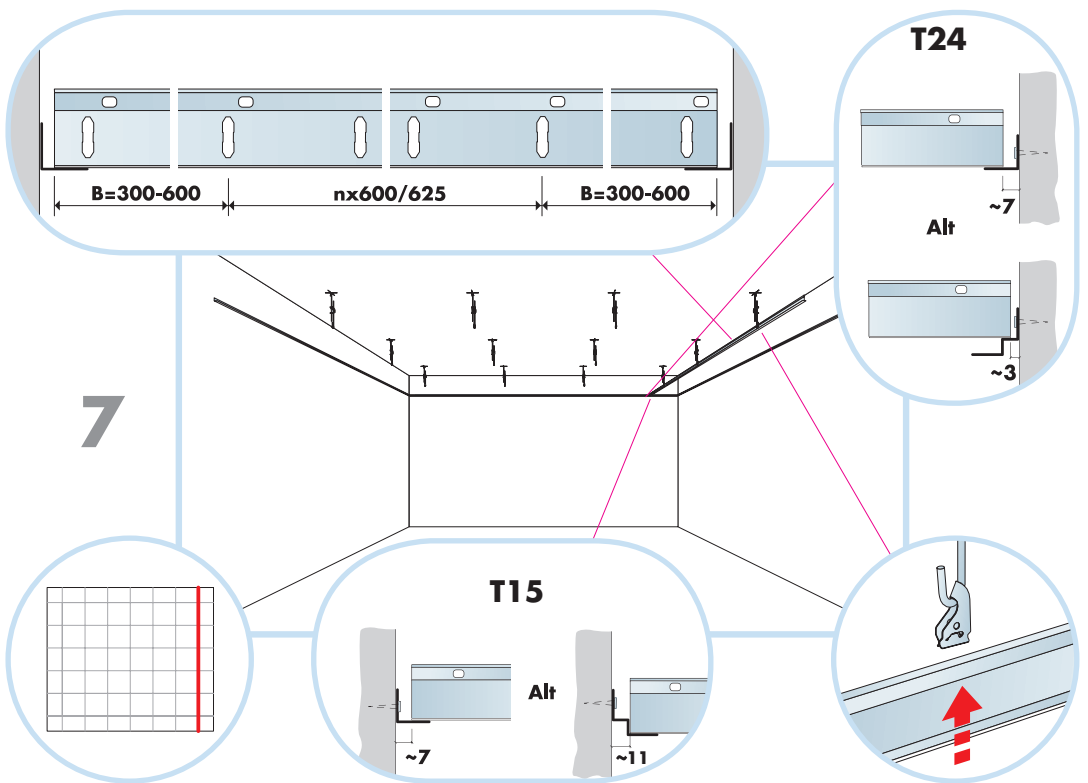
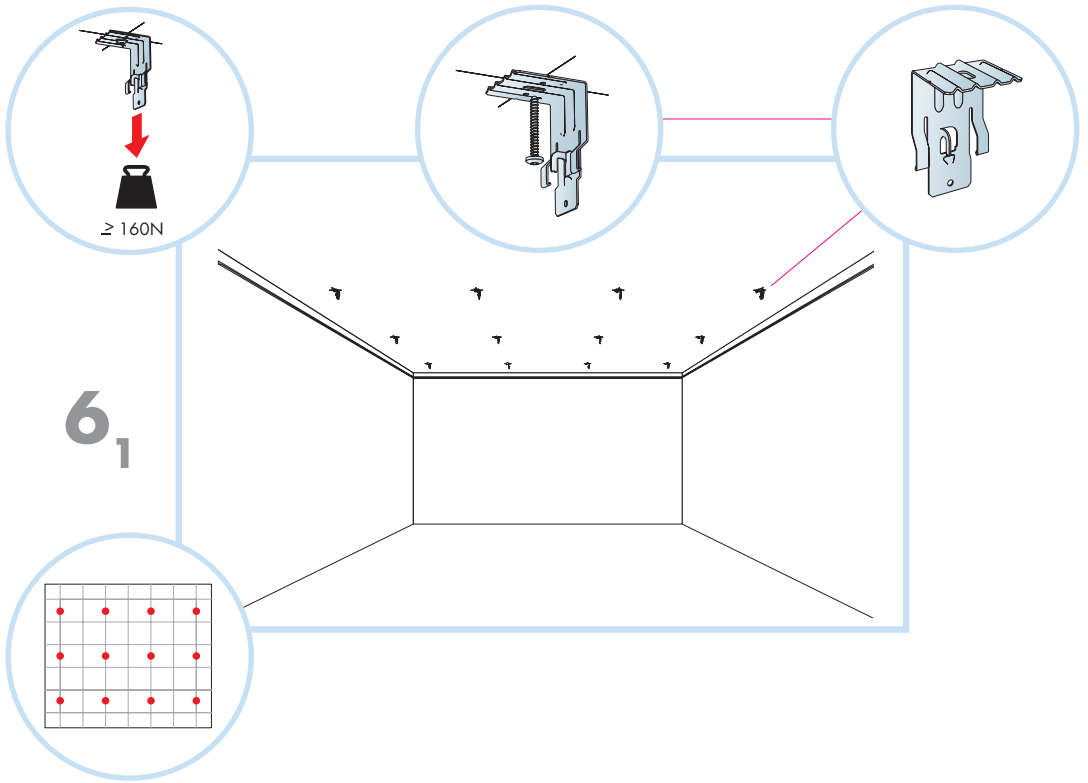

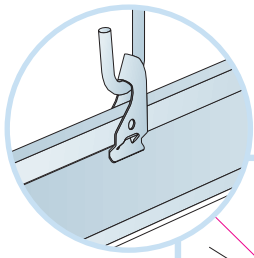

8

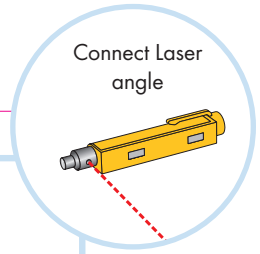
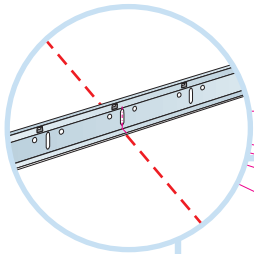
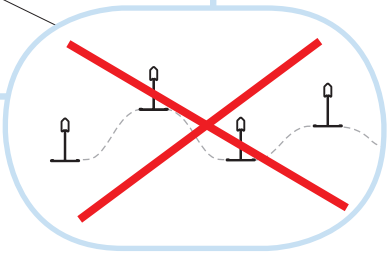
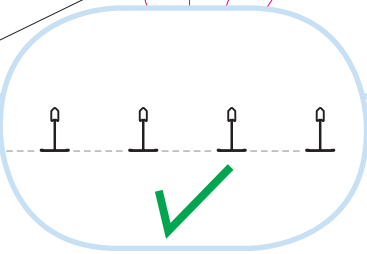
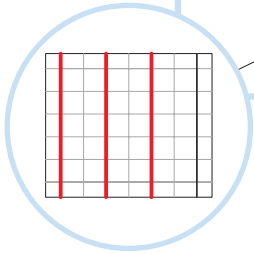
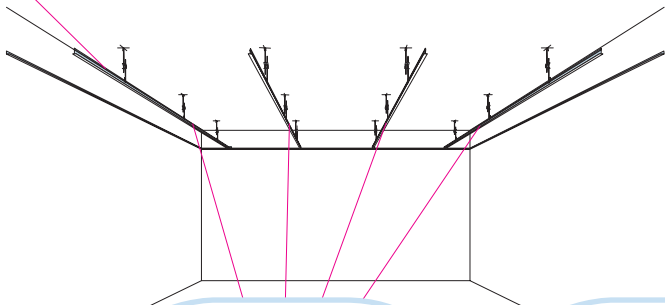

8₁

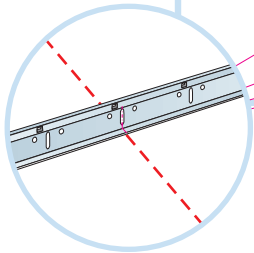
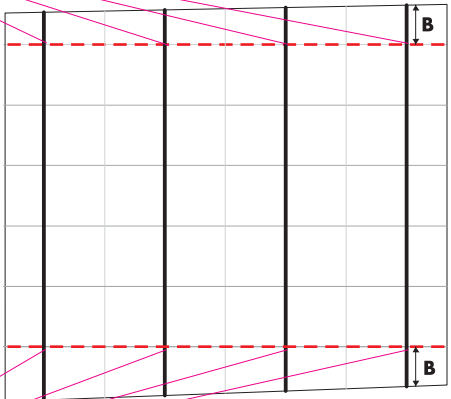

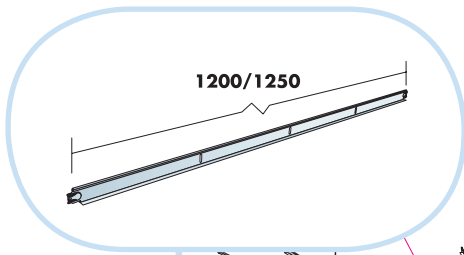

9

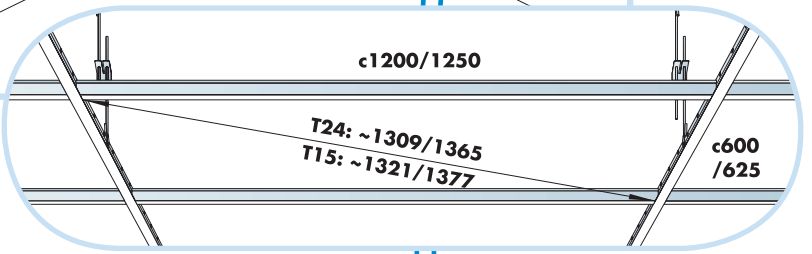
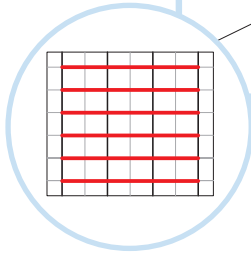
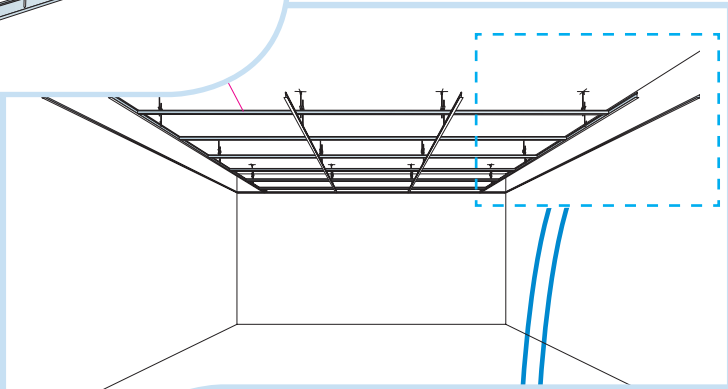

9₁



9₁

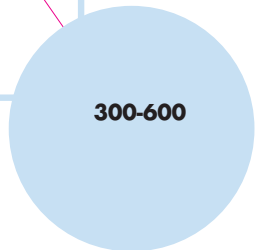
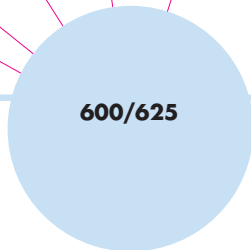
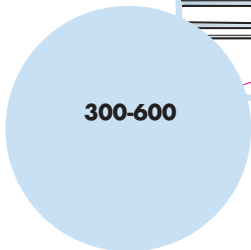
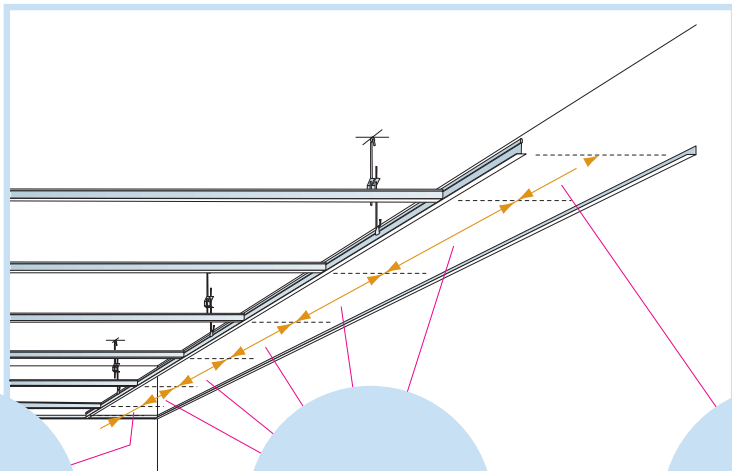

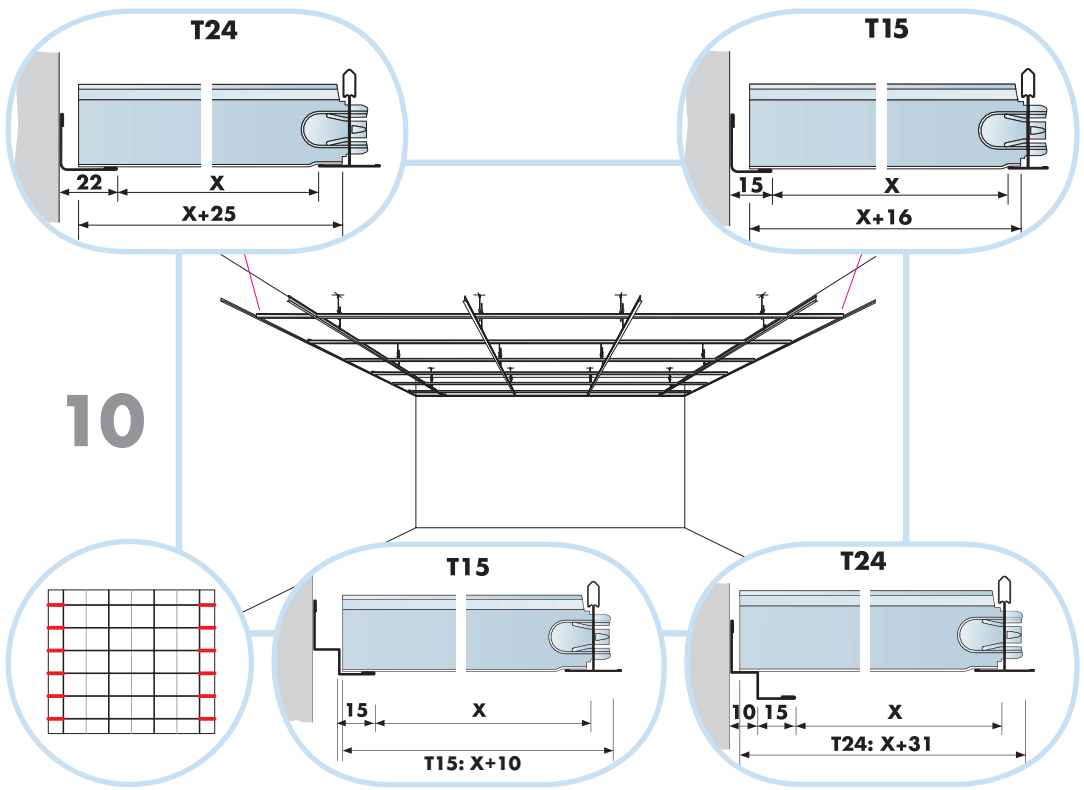

600x600/625x625 → 11

1200x600/1250x625 → 12

11

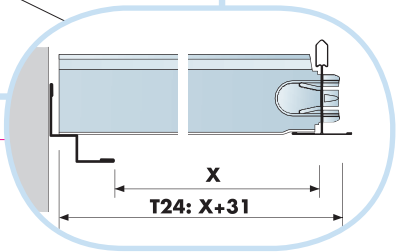
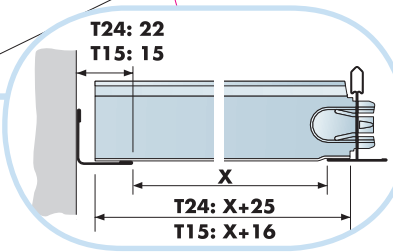
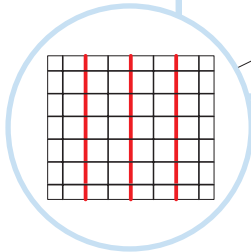
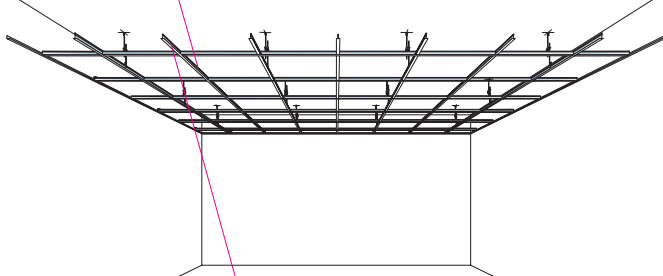
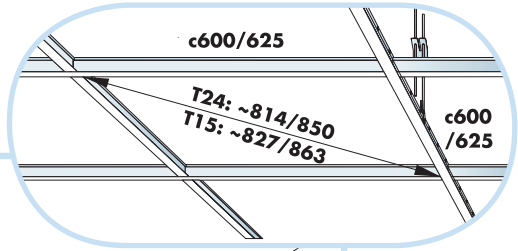
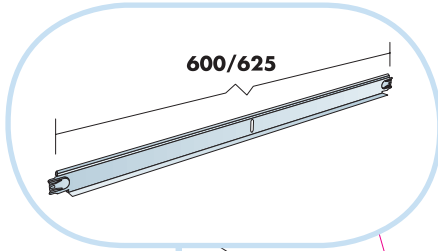

T24

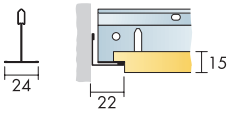

T15

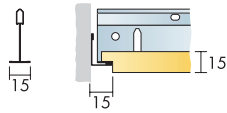

A-A

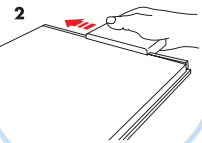
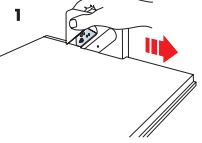
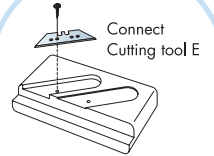
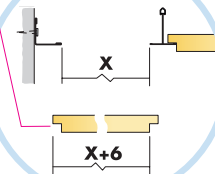

12

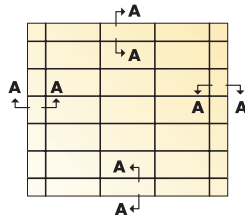

1200x600/1250x625

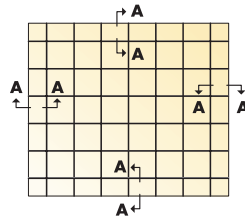

600x600/625x625

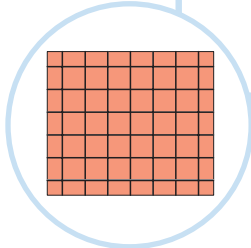

A-A

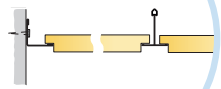

T24

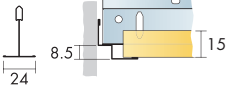

T15

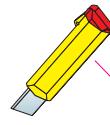
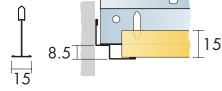

A-A



X+13

15

13

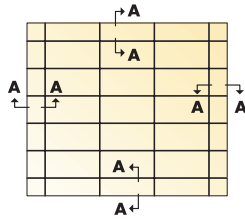

1200x600/1250x625

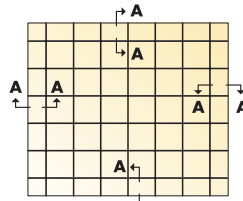

600x600/625x625

A-A

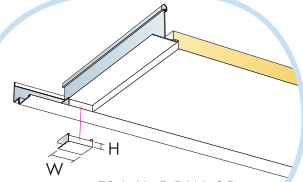
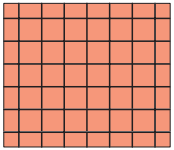
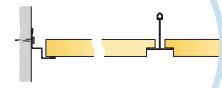

T24: H=5.5 W=25

T24

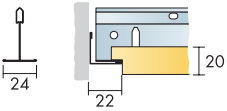

T15

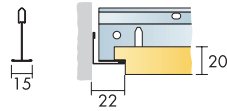

A-A

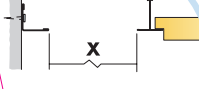

X+9

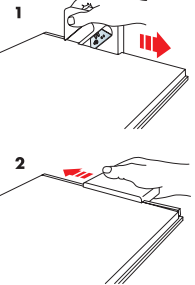
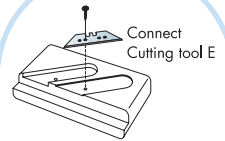

20

14

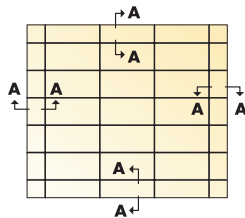

1200x600/1250x625

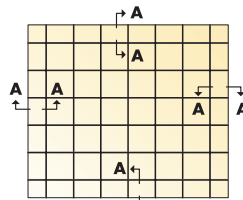

600x600/625x625

A-A

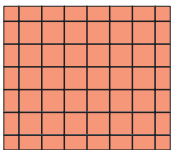
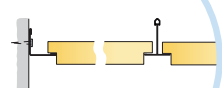

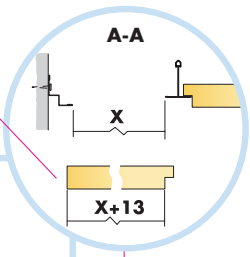
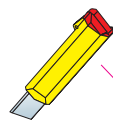
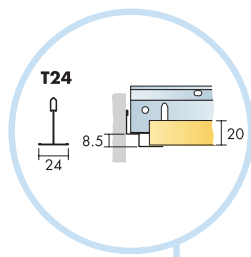

15

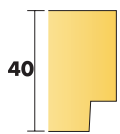
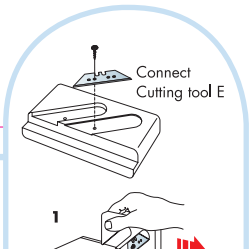
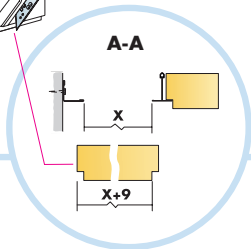
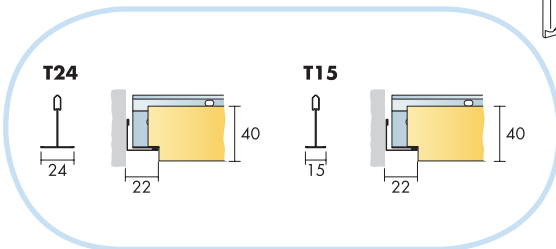
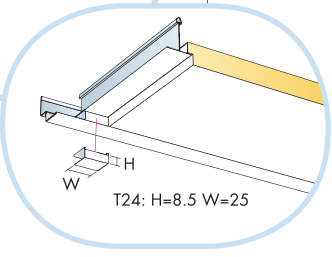
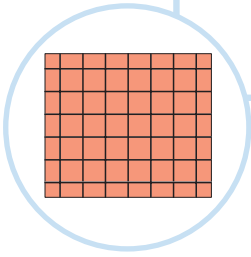
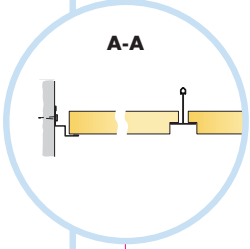
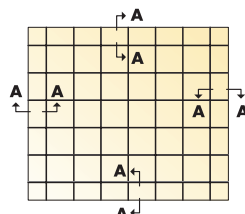
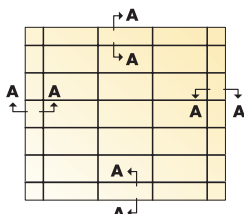

16

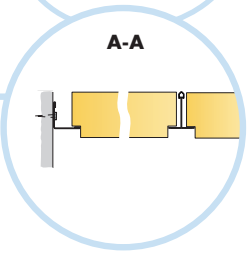
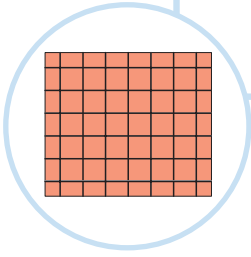
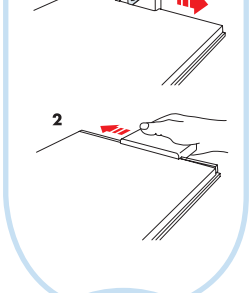
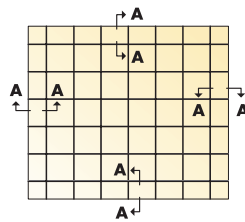
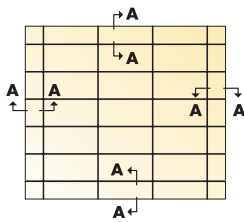

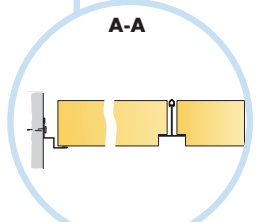
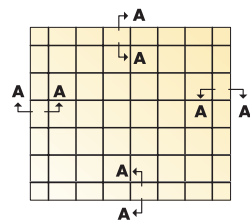
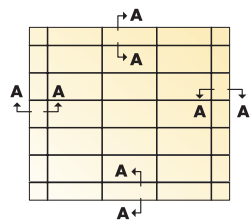
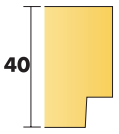
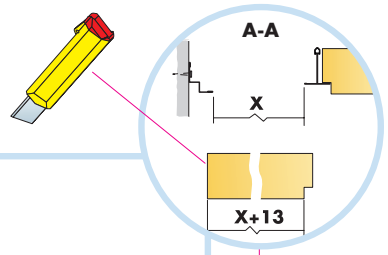
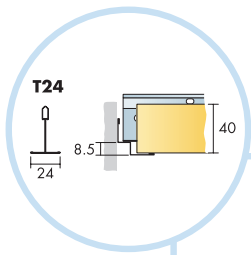

17

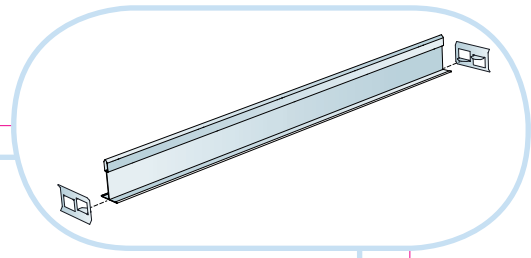
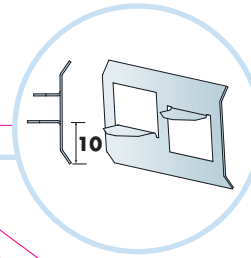
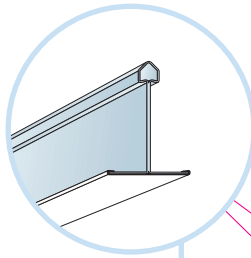
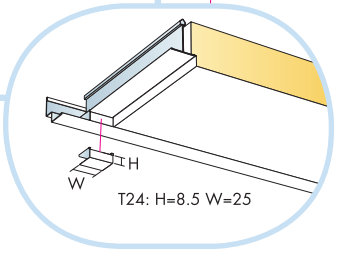
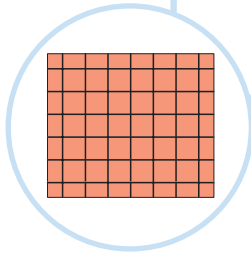

19

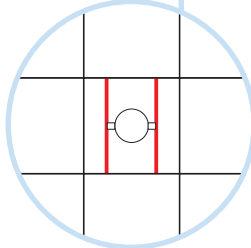
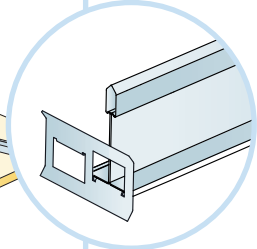
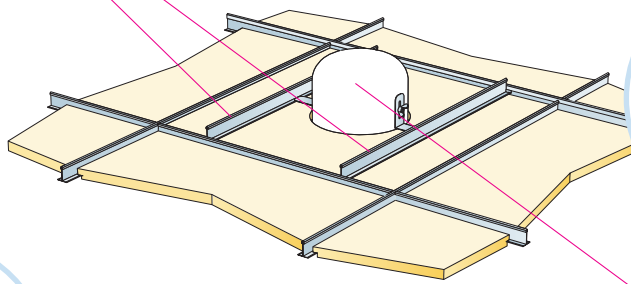

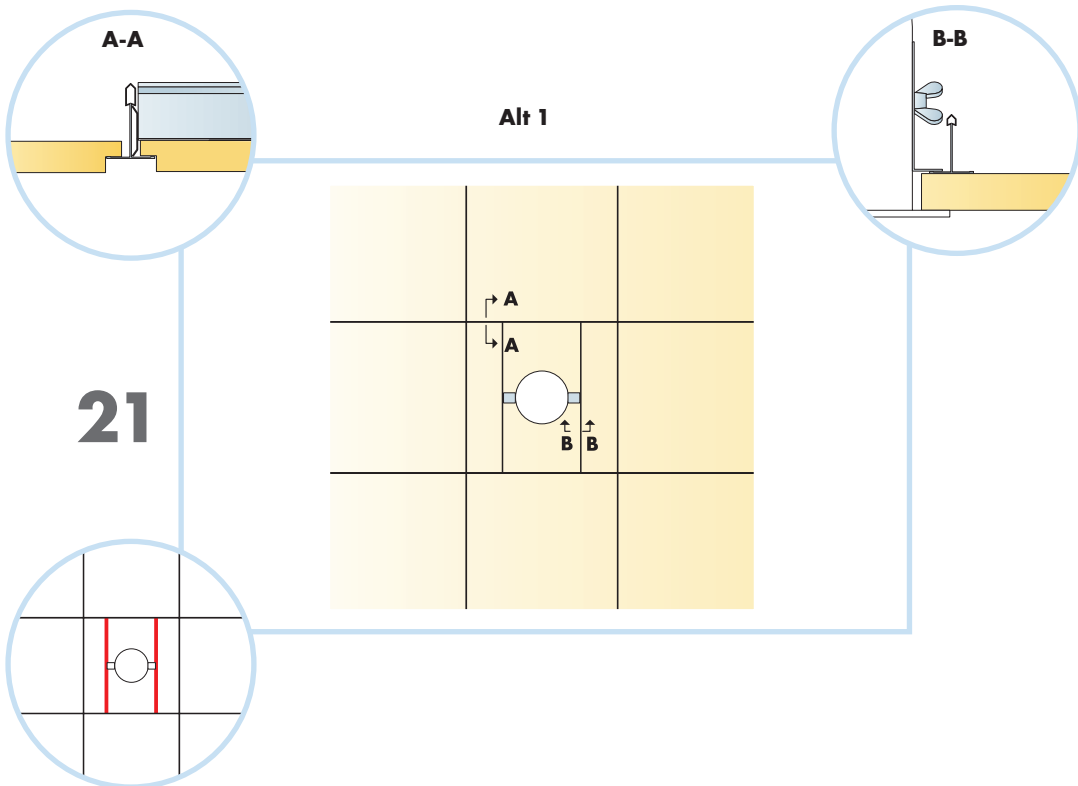
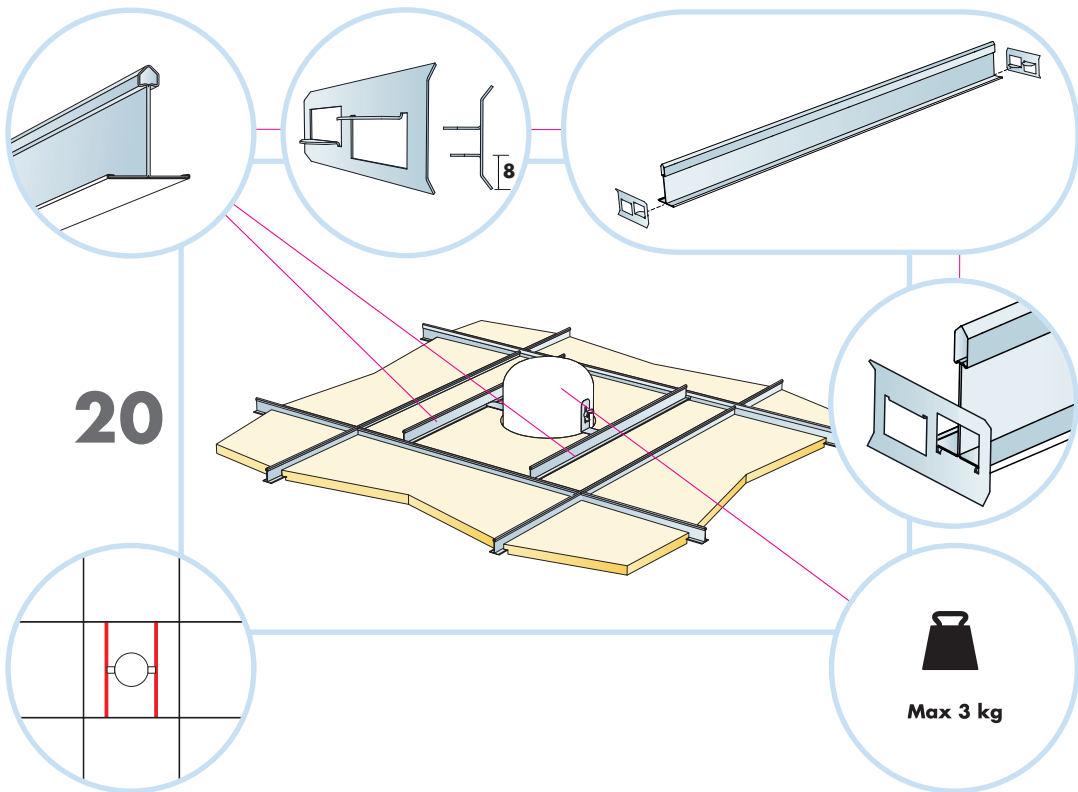

Alt 2

A-A

B-B

C-C

22

A
A
B
B
C
C

Alt 3

23

